

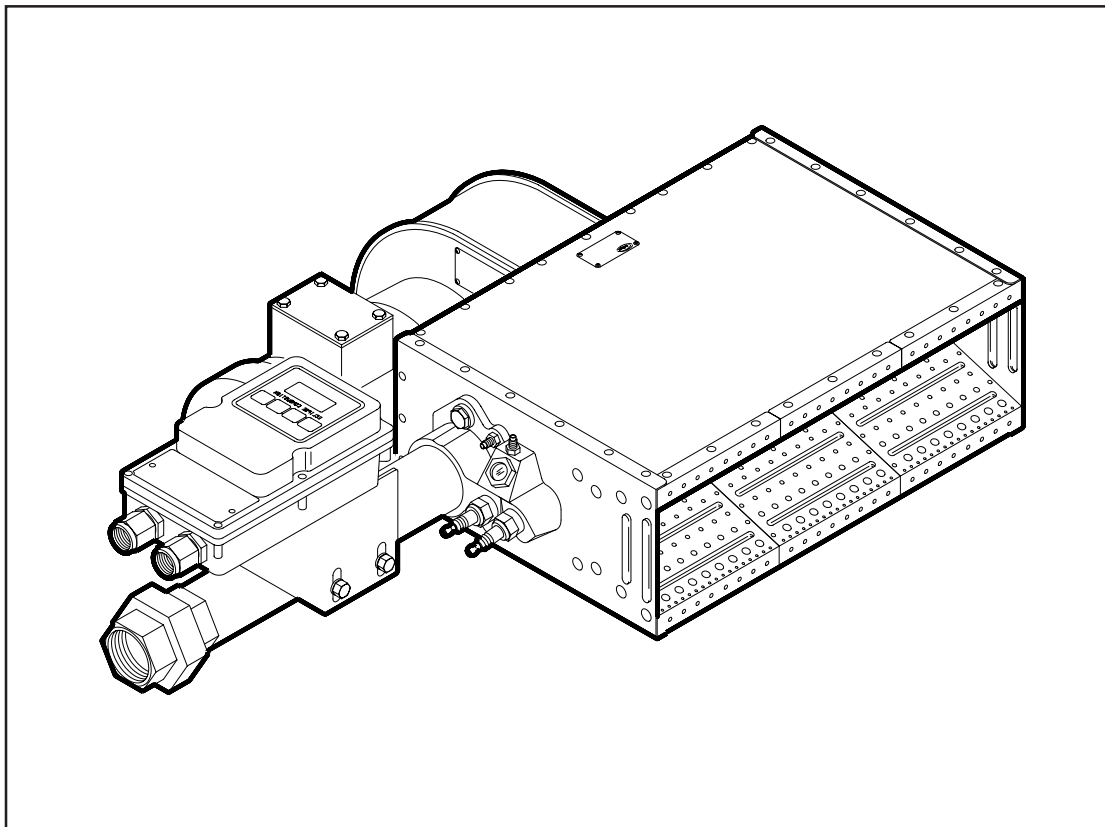

Eclipse AirHeat Burners

AH Series version 2.00

(Patent Pending)



Eclipse Combustion

COPYRIGHT

Copyright 1999 by Eclipse Combustion, Inc. All rights reserved worldwide. This publication is protected by federal regulation and shall not be copied, distributed, transmitted, transcribed or translated into any human or computer language, in any form or by any means, to any third parties, without the express written consent of Eclipse Combustion, Inc., Rockford, Illinois, U.S.A.

DISCLAIMER NOTICE

We reserve the right to change the construction and/or configuration of our products at any time without being obliged to adjust earlier supplies accordingly.

The material in this manual is believed adequate for the intended use of the product. If the product, or its individual modules or procedures, are used for purposes other than those specified herein, confirmation of their validity and suitability must be obtained. Eclipse Combustion, Inc. warrants that the material itself does not infringe any United States patents. No further warranty is expressed or implied.

We have made every effort to make this manual as accurate and complete as possible. Should you find errors or omissions, please bring them to our attention so that we may correct them. In this way we hope to improve our product documentation for the benefit of our customers. Please send your corrections and comments to our Documentation Manager.

LIABILITY AND WARRANTY

It must be understood that Eclipse Combustion's liability for its products, whether due to breach of warranty, negligence, strict liability, or otherwise, is limited to the furnishing of such replacement parts and Eclipse Combustion will not be liable for any other injury, loss, damage or expenses, whether direct or consequential, including but not limited to loss of use, income of or damage to material arising in connection with the sale, installation, use of, inability to use or the repair or replacement of Eclipse Combustion's products.

Any operation expressly prohibited in this Guide, any adjustment, or assembly procedures not recommended or authorized in these instructions shall void the warranty.



About this manual

AUDIENCE

This manual has been written for people who are already familiar with all aspects of a nozzle-mix burner and its add-on components, also referred to as “the burner system.”

These aspects are:

- installation
- use
- maintenance.

The audience is expected to have had experience with this kind of equipment.

PURPOSE

The purpose of this manual is to ensure the installation of a safe, effective, and trouble-free combustion system is carried out.

AIRHEAT DOCUMENTS

Installation Guide No. 135

- This document

AirHeat Data Sheet 135

- Available for all AH models
- Required to complete design & selection

Design Guide No. 135

Used with Data Sheet to design burner system

AirHeat v2.00 Price List No. 135

Used to order burners

RELATED DOCUMENTS

- EFE 825 (Combustion Engineering Guide)
- Eclipse Bulletins and Info Guides: 710, 720, 732, 742, 760, 818, 832, 852, 854, 856, 610, 620, 630, 826, 820, 930, I-354.

DOCUMENT CONVENTIONS

There are several special symbols in this document. You must know their meaning and importance.

The explanation of these symbols follows below. Please read it thoroughly.



Danger:

Indicates hazards or unsafe practices which **WILL result in severe personal injury or even death. Only qualified and well trained personnel are allowed to carry out these instructions or procedures.**
Act with great care and follow the instructions.



Warning:

Indicates hazards or unsafe practices which could result in severe personal injury or damage.

Act with great care and follow the instructions.



Caution:

Indicates hazards or unsafe practices which could result in damage to the machine or minor personal injury. Act carefully.



Note:

Indicates an important part of the text. Read thoroughly.

HOW TO GET HELP

If you need help, contact your local Eclipse Combustion representative. You can also contact Eclipse Combustion at any of the addresses listed on the back of this document.



Table of contents

	About this manual	3
	Audience	3
	Purpose	3
	AirHeat Documents	3
	Related Documents	3
	Document Conventions	4
	How to Get Help	4
	Table of Contents	5
1	Introduction	7
	Product Description	7
2	Safety	8
	Capabilities	9
	Operator Training	9
	Replacement Parts	9
3	Installation	10
	Handling and Storage	10
	Approvals of Components	10
	Electrical Wiring	11
	Gas Piping	11
	Where to get standards	11
	Pre-installation Checklist	12
	Burner Mounting	12
	Installing the flame sensor	14
	Check List After Installation	15
	Prepare for adjustment	15
4	Adjustment, Start & Stop	16
	Introduction	16
	Burner adjustment	16
	Step 1 Reset the system	16
	Step 2 Set Air flow	16
	Step 3a Ignite the burner (Direct Spark)	17
	Step 3b Ignite the burner (Pilot)	17
	Step 4 Set high fire gas	18
	Step 5 Set low fire gas	18
	Step 6 Verify gas settings	18
	Step 7 Stop procedure	18

5

Maintenance & Troubleshooting	19
Maintenance	19
Monthly Checklist	19
Yearly Checklist	20
Troubleshooting Procedures	21
Appendix	24
Conversion Factors	24
Key to System Schematics	25

Introduction

1

PRODUCT DESCRIPTION

Eclipse AirHeat v2.00 Burners are line type burners ideal for generating large volumes of clean, hot air. Applications include ovens, dryers, fume incinerators, and similar industrial equipment. Burners are constructed of aluminum burner bodies and diverging stainless steel air wings. The burner bodies supply fuel to the center of the air wings. The air and fuel mixture inside the burner is controlled to optimize emissions and efficiency.

AirHeat v2.00 Burners are assembled from straight sections allowing for customized inputs. An integral combustion air blower can be ordered mounted on the back of the burner's steel case. By supplying the correct air volume and pressure to the burner, the blower allows stable operation over a wide range of duct velocities without installing a profile plate around the burner.

Brackets are available for slot firing or duct mounting and flanges are available for continuous flange mounting. Right hand or left hand gas piping can be supplied with BSP or NPT connections. A reduced port fuel control valve can be supplied with a variety of control motor and linkage options. Ignition can be by direct spark or by spark ignited pilot. Flame rod flame supervision can be from either or both ends. Several air flow switches are also available factory mounted on the burner.

AirHeat v2.00 Burners



Burner with blower

Burner less blower with inlet gas piping and fuel control valve and continuous mounting flanges.

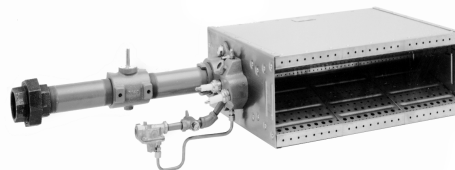
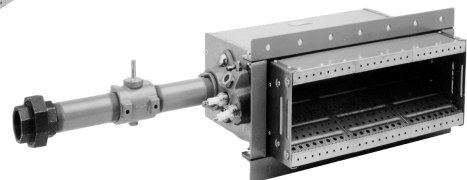

Burner less blower with inlet gas piping and fuel control valve and spark ignited pilot.



2

INTRODUCTION

SAFETY

This section is provided as a guide for the safe operation of the AirHeat burner system. All involved personnel should read this section carefully before operating this system.



Danger:

The AirHeat burners, described herein, are designed to mix fuel with air and burn the resulting mixture. All fuel burning devices are capable of producing fires and explosions if improperly applied, installed, adjusted, controlled, or maintained.

Do not bypass any safety feature; fire or explosion could result.

Never try to light a burner if it shows signs of damage or malfunction.



Warning:

The burner might have HOT surfaces. Always wear protective clothing when approaching the burner.



Note:

This manual provides information in the use of these burners for their specific design purpose. Do not deviate from any instructions or application limits described herein without written advice from Eclipse Combustion.

Read the entire manual before attempting to start this system. If you do not understand any part of the information contained in this manual, contact your local Eclipse representative or Eclipse Combustion before continuing.

CAPABILITIES

Only qualified personnel, with good mechanical aptitude and experience on combustion equipment, should adjust, maintain, or troubleshoot any mechanical or electrical part of this system.

OPERATOR TRAINING

The best safety precaution is an alert and trained operator. Train new operators thoroughly and have them demonstrate an adequate understanding of the equipment and its operation. A regular retraining schedule should be administered to ensure operators maintain a high degree of proficiency.

REPLACEMENT PARTS

Order replacement parts from Eclipse Combustion only. All Eclipse Combustion approved, customer supplied valves or switches should carry UL, FM, CSA, CGA, and/or CE approval, where applicable.

Installation

3

INTRODUCTION

HANDLING AND STORAGE

APPROVALS OF COMPONENTS

Limit Controls and Safety Equipment

In this section you will find important notices about safe operation of the burner:

Handling:

1. Make sure that the components are clean and free of damage.
2. Protect the components from weather, damage, dirt and moisture.
 - Transport in original shipping container
 - Do not drop
3. Protect the components from excessive temperatures and humidity.
4. Use appropriate support equipment, i.e. harnesses, straps, chains etc. when lifting burner components.

Storage:

1. Make sure that the area is clean.
2. Store the components in a cool, clean, dry room.
3. After you have made sure everything is present and in good condition, keep the components in the original package as long as possible.

All limit controls and safety equipment must comply with the current following standards:

- NFPA Standard 86
- NFPA Standard 86C
- UL
- FM
- CGA
- EN 746-2
- all applicable local codes and/or standards.

Electrical wiring

All electrical wiring must comply with one of these standards:

- NFPA Standard 70
- ANSI-C11981
- EN 746-2
- the electrical wiring must be acceptable to the local authority having jurisdiction

Gas Piping

All gas piping must comply with one of these standards:

- NFPA Standard 70
- ANSI Z223
- EN 746-2
- the gas piping must be acceptable to the local authority having jurisdiction

Where to get standards

The NFPA Standards are available from:
National Fire Protection Agency
Batterymarch Park
Quincy, MA 02269

The ANSI Standards are available from:
American National Standard Institute
1430 Broadway
New York, NY 10018

The UL Standards are available from:
333 Pfingsten Road
Northbrook, IL 60062

The FM Standards are available from:
1151 Boston-Providence Turnpike
P.O. Box 9102
Norwood, MA 02062

Information on the EN standards, and where to get the standards is available from:

Comité Européen de Normalisation
Strassartstraat 36
B-1050 Brussels
Phone: +32-25196811
Fax: +32-25196819

Comité Européen de Normalisation Electronique
Strassartstraat 36
B-1050 Brussels
Phone: +32-25196871
Fax: +32-25196919

PRE-INSTALLATION CHECKLIST

Air Supply

If there are corrosive fumes or materials in the surrounding air, find an uncontaminated source to supply air to the burner. Observe ambient temperature limits as stated in Data 135.

- **Combustion Air From Outside Duct**

Provide an opening in the burner room of at least one square inch per 4000 BTU/hr (6 cm² per 1 kW) to supply the burner intake with fresh, outdoor, combustion air.

- **Combustion Air From Inside Duct**

There must be a minimum of 18% O₂ present in the process air flow to ensure proper burner performance.

Exhaust

Do not allow exhaust gases to accumulate in the work area. Provide a means for exhausting these gases from the building.

Access

Install the burner so it may be easily accessed for inspection and maintenance.

Environment

Be sure the burner operating environment matches the original operating specifications. Check the following items:

- voltage, frequency, and stability of electrical power
- fuel type and fuel supply pressure
- adequate fresh, clean, combustion air
- humidity, altitude, and temperature of the supply air
- presence of damaging corrosive gases in the air
- prevent direct exposure to water.

Note:



Mounting dimensions for all mounting options are found in Data 135.

Guidelines for all mounting options

- Center the burner in the duct
- Allow a minimum of 41" (1042 mm) from burner to nearest point of possible flame impingement at an input of 1,000,000 Btu/hr. (961kW/m) and ΔP air = 1.0" w.c.
See Data 135 for more information about flame lengths at other burner settings.
- On burners longer than 36" (914 mm), use a hanger or a pedestal to support the blower and motor.
- The duct structure must be strong enough to support the weight of the burner. If necessary, reinforce the mounting area.
- Process air velocity must be within the limits stated on page 5 of Data 135.

BURNER MOUNTING

BURNER MOUNTING (CONTINUED)

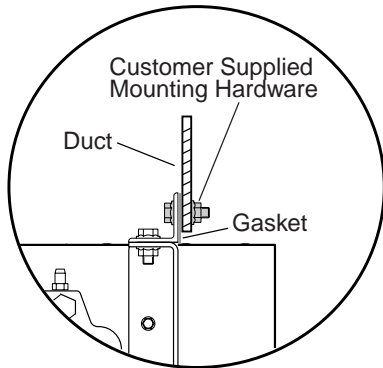

**Continuous Mounting
(Side View)**

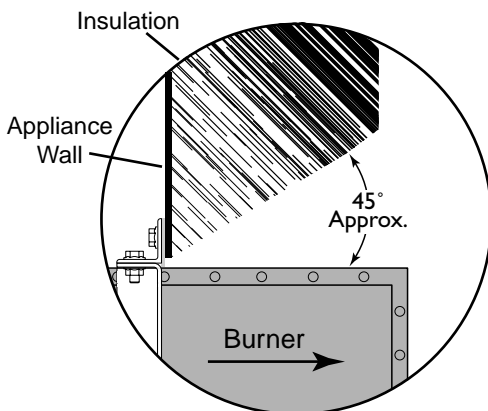

**Continuous Mounting
(Top View)**

In Duct Mounting

When laying out the duct, allow enough length downstream of the burner to avoid flame impingement; see page 2 of Data 135 for flame lengths.

Provide at least 3" (76 mm) clearance between the burner and the top, bottom and sides of the duct.

Profile plates are not required for good burner operation, but uniform velocity must be maintained for the full length of the burner. If velocity is not uniform, profile plates can be used to correct this condition.



Caution

Profile plates should be positioned flush with the firing end of the burner. If necessary, the plates can be located up to 1/2" back from the firing end, but under no circumstances should they be in front of the burner.

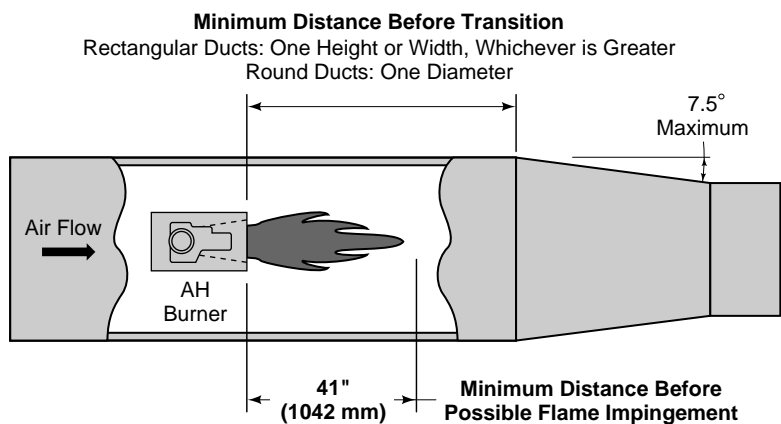

Slot Firing

Firing end of the burner must extend into the duct.

Continuous Mounting (Sealed Firing)

Provide an opening in the duct 1/2" (12mm) larger than the external burner dimensions. (1/4" (6mm) gap on all 4 sides.) Customer must supply a suitable gasket between the mounting flange and the duct wall.

If insulation is 1" (25mm) or greater in thickness, it must be beveled away from the left and right end plates at approximately 45°.

Burner Piping

The burner is factory assembled and shipped as ordered.



Note:

If it is necessary to redirect piping, the burner may be inverted. Burner, fuel control BV and blower are not position conscious. All other items i.e. valves, switches actuators etc. must be installed in accordance with manufacturers requirements.

BURNER MOUNTING

(CONTINUED)

Supply Piping

- Locate the valve train close to the burner. The gas must reach the burner during the fixed trial for ignition.
- Sufficiently size shut off valves in the valve train.
- Make sure piping is large enough.
- Minimize piping elbows.

Pipe Connections

- Installation of a pipe union in the gas line is recommended to simplify burner removal.
- Use of flexible pipe is optional.



Note:

Flexible pipe causes higher pressure drops than standard pipe. Consider this when sizing your gas lines.

Piping Support

Use brackets or hangers to support the gas piping. If you have questions, consult your local gas company.

Control Motor

Install a control motor to modulate the gas control valve if not previously installed on the burner.

Installing the flame sensor

There are two different types of flame sensors:

U.V. scanner:

Each AirHeat burner is capable of U.V. flame monitoring. The burner will not come equipped with a U.V. scanner. A ½” NPT connection is provided on each AirHeat burner for the connection of a U.V. scanner.

For detailed information on how to install and connect an Eclipse U.V. scanner, refer to:

- straight U.V. scanner; Bulletin / Info Guide 854
- 90° U.V. scanner; Bulletin / Info Guide 852
- self-check U.V. scanner; Bulletin / Info Guide 856.

Flame rod:

If the flame rod option was selected when the burner was ordered, the burner will be delivered with the flame rod already installed on the burner

For detailed information on how to install and connect a flame rod, refer to:

- Bulletin / Info Guide 832.

CHECK LIST AFTER INSTALLATION

PREPARE FOR ADJUSTMENT

To verify the system was properly installed, perform the following checks:

1. Be sure there are no leaks in the gas lines.
2. Be sure all the components contained in the flame monitoring and control system are properly installed. This includes verifying that:
 - all the switches are installed in the correct locations.
 - all wiring and pressure lines are properly connected.
3. Be sure all components of the spark ignition system are installed and functioning properly.
4. Be sure the blower rotates in the proper direction. If the rotation is incorrect, have a qualified electrician rewire the blower to rotate in the proper direction.
5. Be sure all valves are installed in the proper location and correctly oriented relative to the flow direction.

After installation of the burner system components is complete, the following steps should be followed in order to prepare for adjustment:

1. Set the air flow switch so that it drops out at 20% below the maximum pressure of the combustion air blower.
2. Set the low gas pressure switch at 20% below the gas pressure measured at the inlet to the main gas valve train.
3. Set the high gas pressure switch at 20% above the gas pressure measured at the inlet to the main gas valve train.
4. Close all manual valves feeding the burner.
5. Try to ignite the burner before the purge and other timers have finished their cycles. Make sure that the flame monitoring system indicates a flame failure.
6. Trip out the pressure switches and other limit interlocks. Make sure that the main gas valve train closes.



Danger:

If simulated limits or simulated flame failures do not shut down the fuel system within the required failure response time, immediately correct the problem before proceeding.

Adjustment, Start & Stop

4

INTRODUCTION

In this chapter you will find instructions on how to start and stop a burner. The chapter begins with general instructions that are useful for adjustment.



Danger:

The AirHeat burners, described herein, are designed to mix fuel with air and burn the resulting mixture. All fuel burning devices are capable of producing fires and explosions if improperly applied, installed, adjusted, controlled, or maintained.

Do not bypass any safety feature; fire or explosion could result.

Never try to light a burner if it shows signs of damage or malfunction.

BURNER ADJUSTMENT

If you are adjusting an AirHeat burner for the first time, you must follow these steps:

1. Reset the system
2. Set air flow
3. Ignite the burner
4. Set high fire gas
5. Set low fire gas
6. Verify gas settings
7. Stop Procedure

Step 1: Reset the system

1. Start circulating duct fan.
2. Close these valves
 - the automatic gas valves
 - the manual gas cocks
3. Start the combustion air blower

Step 2: Set air flow

Measure the air pressure drop across the burner between Tap "A" and Tap "C". (See page 5 of Data I35.) Turn the disc on the blower air inlet until the air pressure is between 0.6" w.c. (1.5mbar) minimum and 1.2" w.c. (3.0mbar) maximum. For a given input, lower air pressure drops will produce a longer flame, and higher drops will produce a shorter flame with slightly higher CO levels.

**Step 3a: Ignite the burner
(Option 1: Direct Spark
Ignition))**

There are two separate ignition procedures which depend upon whether or not a pilot is installed on the burner. Each procedure is unique and both are outlined below.



Warning:

Both procedures assume that a flame monitoring control system is installed and is serviceable.

1. Drive the gas control valve to low fire.



Note:

All AirHeat burners are limited to direct spark ignition at inputs below 60% of maximum.

2. Make sure the combustion air blower is running.
3. Open all manual gas valves feeding the burner.
4. Initiate the ignition sequence through the flame monitoring control system.
5. Verify that the burner has ignited.

If the burner does not ignite:

- a) Try to ignite again to purge the air out of the gas piping.
- b) If the burner does not ignite after one or two additional ignition attempts, see the Trouble shooting Guide contained in the Maintenance & Troubleshooting section of this guide.

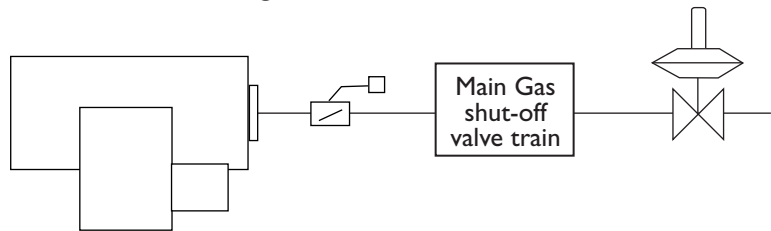

**Step 3b: Ignite the burner
(Option 2: Burner equipped
with spark ignited pilot)**



Note:

Ignition is possible at all inputs using spark ignited pilot.

1. Drive the gas control valve to low fire.
2. Make sure the combustion air blower is running.
3. Open all pilot gas valves including the handle of the adjustable port pilot gas cock.
4. Verify that the pilot has ignited.
5. Initiate the ignition sequence through the flame monitoring control system.

If the pilot does not ignite:

- a) Try to ignite again to purge the air out of the gas piping.
- b) If the pilot does not ignite after one or two additional ignition attempts, see the Trouble shooting Guide contained in the Maintenance & Troubleshooting section of this guide.

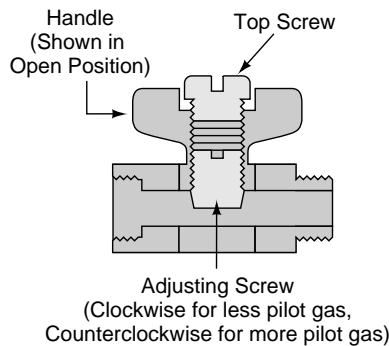

Adjustable Port Pilot Gas Cock

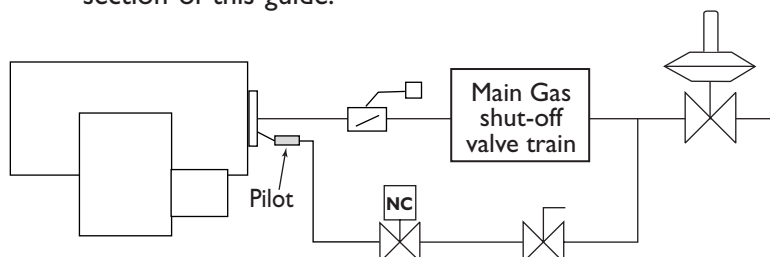

Step 4: Set high fire gas

1. If the burner is ignited, set the main gas pressure regulator for 10" w.c. outlet pressure.
2. Drive the main gas control valve to high fire (full open).
3. Verify air flow with the burner firing, if necessary, repeat Step 2 "Set air flow".
4. Make sure that pressure taps B and C are open.
5. Connect the manometer to taps B and C.
6. Measure the gas differential pressure.
7. Use the fuel ΔP curve from Data Sheet 135 for the gas being used to find the differential gas pressure needed at high fire.
8. Adjust the outlet pressure from the main gas pressure regulator to achieve the desired gas flow.
9. Once the chamber conditions stabilize, (i.e. pressure and temperature), repeat Steps 3 through 8.
10. Remove the manometer.
11. Close the pressure taps.

Step 5: Set low fire gas

1. Drive the main gas control valve to low fire.
2. Adjust the control valve linkage to provide the desired low fire gas flow.



Note:

It is very difficult to measure the very low gas pressures experienced at low fire, and it may be necessary to rely on visual inspection of the flame. This is especially true when gas turndowns in excess of 20 to 1 are being used. The main intent is to provide a stable flame with good flame signal that will not cause the chamber temperature to overshoot.

Step 6: Verify gas settings

Make sure that all settings are still the same after cycling the system several times between high and low fire.

Step 7: Stop Procedure



Caution:

Do not turn the combustion air blower off until the chamber temperature is below 250°F (121°C). This will prevent hot gases from back flowing into the burner and blower causing damage to the burner.

1. Stop the burner through the burner control system.
2. Run the combustion air blower until the chamber temperature drops below 250°F (121°C).
3. Shut off the combustion air blower.
4. Close all manual gas valves to the burner.

Maintenance & Troubleshooting

5

INTRODUCTION

This chapter is divided into two sections:

- Maintenance procedures
- Troubleshooting guide

Preventive maintenance is the key to a reliable, safe and efficient system. The core of any preventive maintenance system is a list of periodic tasks.

MAINTENANCE



Note:

These are guidelines only. The customer should make the final determination on maintenance intervals and tasks to be performed while considering the working environment.

Monthly Checklist

1. Inspect the flame sensing devices for good condition and cleanliness.
2. Check for proper air and gas pressures (Refer to the Data Sheet 135).
3. Test all the system alarms for proper response signals.
4. Check and clean igniter electrodes.
5. Check valve motors and control valves for free, smooth action and adjustment.
6. Check for the proper operation of ventilating equipment.
7. Test the interlock sequence on all safety equipment. Manually force each interlock to intentionally fail while at the same time noting if related equipment closes or stops as specified by the manufacturer. Test the flame safeguard by manually shutting off the gas to the burner.
8. Test the manual gas shut off cocks for proper operation.
9. Clean and/or replace the combustion air blower filter if applicable.
10. Inspect and clean the combustion air blower rotor.

Yearly Checklist

1. Leak test the safety shut-off valves for tightness of closure.
2. Test the pressure switch settings by checking the switch movements against pressure settings and comparing these with the actual impulse pressure.
3. Visually check igniter cable and connectors.
4. Be sure the following components are not damaged or distorted:
 - the burner bodies and air wings.
 - the igniter.
 - the flame sensors.

TROUBLESHOOTING PROCEDURES

PROBLEM	POSSIBLE CAUSE	SOLUTION
Cannot initiate a start sequence.	<ul style="list-style-type: none"> Air pressure switch has not made contact. 	Check air pressure switch adjustment. Check air filter. Check blower rotation. Check outlet pressure from blower.
	<ul style="list-style-type: none"> High gas pressure switch has activated. Low gas pressure switch has activated. 	Check incoming gas pressure; adjust if necessary. Check pressure switch setting and operation.
	<ul style="list-style-type: none"> Purge cycle not completed. 	Check flame safeguard system or purge timer.
	<ul style="list-style-type: none"> Malfunction of the flame safeguard system (e.g., shorted-out flame sensor or electrical noise in the sensor line). No power to the control unit. 	Have a qualified electrician troubleshoot and correct the problem.
	<ul style="list-style-type: none"> Main power is off. 	Be sure the main power to the system is switched to the “on” position.
Start-up sequence runs but burner does not light.	PILOT IGNITION ONLY <ul style="list-style-type: none"> Gas pressure into pilot regulator too low. Pilot gas cock closed. Pilot solenoid valve does not open. Gas adjusting valve set too low. Air in the pilot gas line. 	Check outgoing gas pressure of main regulator; increase if necessary. Open pilot gas cock. Have qualified electrician check power supply to solenoid. Increase gas flow. See page 17. Repeat start-up several times to purge air from gas line.
	PILOT IGNITION OR DIRECT SPARK No ignition: <ul style="list-style-type: none"> Attempting to ignite at inputs greater than 60% (direct spark). Weak or non-existent spark. There is no power to the ignition transformer. Open circuit between the ignition transformer and the igniter. 	Reduce start point gas flow. Verify control circuit. Verify ignition transformer is a 6,000 - 8,000 volt transformer. (Not half-wave) Restore the power to the ignition transformer. Repair or replace the wiring to the igniter.

PROBLEM	POSSIBLE CAUSE	SOLUTION
<p>Start-up sequence runs but burner does not light. (continued)</p>	<p>No ignition (continued):</p> <ul style="list-style-type: none"> • The igniter needs cleaning. • The igniter is not correctly grounded to the burner. • Igniter insulator is broken. Igniter is grounding out. 	<p>Clean the igniter.</p> <p>Clean the threads on the igniter and the burner. NOTE: Do not apply grease to the threads on the igniter.</p> <p>Inspect the igniter. Replace if broken.</p>
	<p>Not enough gas:</p> <ul style="list-style-type: none"> • The gas flow into the burner is too low. • Gas valve does not open. 	<p>Check the start-up settings. Adjust low fire gas setting if necessary.</p> <p>Check the wiring to the automatic gas shut-off valve. Check the output from the flame safeguard.</p> <p>Open manual gas cock.</p>
	<p>No flame signal:</p> <ul style="list-style-type: none"> • Broken flamerod • Dirty UV scanner lens • Flamerod grounding out 	<p>Replace if necessary.</p> <p>Inspect and clean sensor.</p> <p>Verify that the flamerod is installed correctly and is the correct length.</p>
<p>The low fire flame is weak or unstable.</p>	<ul style="list-style-type: none"> • Not enough gas • Incorrect air flow setting 	<p>Check start-up settings and adjust to increase gas flow.</p> <p>Check air pressure drop across the burner and adjust.</p>
<p>The burner does not go to high fire.</p>	<ul style="list-style-type: none"> • Not enough gas pressure out of main gas regulator. • Gas pressure drops as input is increased. • Main gas control valve is not functioning. 	<p>Adjust pressure regulator so pressure is provided as stated in Data 135.</p> <p>Check for clogging of valves and regulators in gas line. Pressure regulator may be incorrectly sized. Replace if necessary.</p> <p>Check actuator and linkage.</p>
<p>Burner does not achieve capacity.</p>	<ul style="list-style-type: none"> • Main gas control valve is not functioning. • Burner is firing below rated input. • Burner gas holes are plugged. 	<p>Check actuator and linkage.</p> <p>Check gas pressure differential. Adjust main gas pressure regulator as necessary.</p> <p>Inspect gas holes for dirt or lint as needed.</p>

PROBLEM	POSSIBLE CAUSE	SOLUTION
Main flame is uneven along the length of the burner.	<ul style="list-style-type: none"> • Air pressure drop/velocity is too low. • Poor air distribution in duct. • Air wings are dirty, holes are clogged. 	<p>Increase air pressure drop.</p> <p>Check profiling and duct obstructions.</p> <p>Inspect and clean air wings if necessary.</p>
Main flame is yellow and long at high fire.	<ul style="list-style-type: none"> • Gas pressure too high at burner inlet. • Air wings are dirty, holes are clogged. • Air pressure drop/velocity too low. 	<p>Check gas pressure against design. Adjust main gas pressure regulator.</p> <p>Inspect and clean air wings if necessary.</p> <p>Open air damper on combustion air blower.</p>
CO emission is too high.	<ul style="list-style-type: none"> • Burner is outside range specified in Data 135. • Process air velocity exceeds limits given in Data 135. 	<p>Adjust burner settings.</p> <p>Bring velocity within limits; adjust process air blower.</p>

Appendix

CONVERSION FACTORS

Metric to English.

From	To	Multiply By
cubic meter (m ³)	cubic foot (ft ³)	35.31
cubic meter/hour (m ³ /h)	cubic foot/hour (cfh)	35.31
degrees Celsius (°C)	degrees Fahrenheit (°F)	(°C × 1.8) + 32
kilogram (kg)	pound (lb)	2.205
kilowatt (kW)	BTU/hr	3414
meter (m)	foot (ft)	3.28
millibar (mbar)	inches water column ("w.c.)	0.401
millibar (mbar)	pounds/sq in (psi)	14.5 × 10 ⁻³
millimeter (mm)	inch (in)	3.94 × 10 ⁻²
MJ/m ³ (normal)	BTU/ft ³ (standard)	2.491 × 10 ⁻²

Metric to Metric.







kiloPascals (kPa)	millibar (mbar)	10
meter (m)	millimeter (mm)	1000
millibar (mbar)	kiloPascals (kPa)	0.1
millimeter (mm)	meter (m)	0.001

English to Metric.

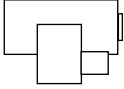
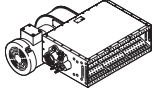
From	To	Multiply By
BTU/hr	kilowatt (kW)	0.293 × 10 ⁻³
cubic foot (ft ³)	cubic meter (m ³)	2.832 × 10 ⁻²
degrees Fahrenheit (°F)	degrees Celsius (°C)	(°F – 32) ÷ 1.8
foot (ft)	meter (m)	0.3048
inches (in)	millimeter (mm)	25.4
inches water column ("wc)	millibar (mbar)	2.49
pound (lb)	kilogram (kg)	0.454
pounds/sq in (psi)	millibar (mbar)	68.95
BTU/ft ³ (standard)	MJ/m ³ (normal)	40.14

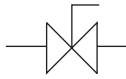
KEY TO SYSTEM SCHEMATICS

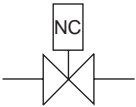
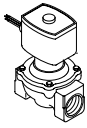
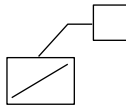
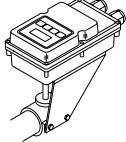
These are the symbols used in the schematics.

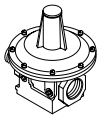
Symbol	Appearance	Name	Remarks	Bulletin/ Info Guide
		AirHeat		
		Main Gas Shutoff Valve Train	Eclipse Combustion, Inc. strongly endorses NFPA as a minimum	756
		Gas Cock	Gas cocks are used to manually shut off the gas supply on both sides of the main gas shut-off valve train.	710
		Solenoid Valve (normally closed)	Solenoid valves are used to automatically shut off the gas supply on a bypass gas system or on small capacity burners.	760
		Automatic Gas Control Valve	An automatic gas control valve adjusts gas flow to the burner based on control system requirements.	720
		Pressure Regulator	A pressure regulator reduces gas pressure to a stable, usable pressure.	684



Offered By:

Power Equipment Company
2011 Williamsburg Road
Richmond, Virginia 23231
Phone (804) 236-3800
Fax (804) 236-3882

www.peconet.com